

# OWNER'S MANUAL



 **Polaris180**

IMPORTANT INFORMATION

SERIAL NUMBER

# Important Information

- Always disconnect the Polaris from the pool wall when cleaning or backwashing the pool filter.
- After cleaning or backwashing, let the filtration system run for at least five minutes before re-connecting the Polaris.
- New plumbing lines should be flushed out before installing the Polaris.
- The Polaris should not be used to remove plaster dust in new pools.
- Always remove the Polaris **before swimmers enter the pool**.
- Except when checking the wheel RPM, do not handle the Polaris while it is operating.
- Always remove the Polaris from the pool before chemical shock treatments.

## For customer service or support:

- Please mail Warranty Card immediately.
- For on-line support: [www.polarispool.com](http://www.polarispool.com)
- To contact Polaris:

### US and Canada

Customer Service  
2620 Commerce Way  
Vista, CA 92081-8438  
1-800-822-7933

### Australia

Unit 4, 19-21 Gibbes Street,  
Chatswood, NSW 2067  
1-300-POLARIS  
ACN 080 168 092

### Europe

C/Osana s/n.  
(Pol.End.El Ramassar),  
98520 Les Franqueses del Vallés  
Barcelona, Spain  
+34 93 840 25 85

## Polaris Vac-Sweep® 180 Limited Warranty

This one year limited warranty is extended to the original consumer purchaser of this Polaris Vac-Sweep 180 Automatic Pool Cleaner manufactured by Polaris Pool Systems, Inc., from date of manufacture of the unit as established by the serial number, or one year from date of purchase with proof of purchase, whichever is later. Polaris warrants this product, including all parts and components thereof, to be free of defects in material and workmanship. Normal replacement items such as bags, tires, sweep hoses or sweep hose scrubbers which have been worn out by use or improper installation are not covered by this warranty.

This limited warranty does not apply if the failure is caused or contributed to by any of the following: improper handling, improper usage, improper storage, winter freezing, abuse, improper installation, removal of the UWF filter screen, unsuitable application of the unit, improper maintenance, lack of reasonable and necessary maintenance, damage in transit or during installation, or damage from repairs/alterations made or attempted by anyone other than Polaris or one of its Authorized Service Centers. In no event shall Polaris be liable for incidental or consequential damages of any nature or for damages to persons or property, including damage to vinyl liners, plaster, tile, aggregate-based and other pool surfaces, or damages resulting from the use of this product with a standard pool circulation system or chemical imbalance.

Authorization to return a unit or part to the plant of manufacture must be obtained from the Polaris Customer Service Department. Check with your dealer for the local procedure before exercising this warranty. If further directions or instructions should be required, contact the Customer Service Department at 1-800-VAC-SWEEP (USA and Canada only) or (760) 599-9600. Be sure to insure the shipment against loss or damage in transit.

This limited warranty is valid only in the United States of America, Canada and Australia, and it does not apply to Polaris Vac-Sweep 180 Automatic Swimming Pool Cleaners sold or installed in any other country. Polaris Vac-Sweep 180 Automatic Pool Cleaners sold in the United Kingdom are warranted for a period of two years from date of invoicing to the first user.

### WARNING: USE OF POLARIS 180 IN A VINYL LINER POOL

Certain vinyl liner patterns are particularly susceptible to rapid surface wear or pattern removal caused by objects coming into contact with the vinyl surface, including pool brushes, pool toys, floats, fountains, chlorine dispensers, and automatic pool cleaners. Some vinyl liner patterns can be seriously scratched or abraded simply by rubbing the surface with a pool brush. Ink from the pattern can also rub off during the installation process or when it comes into contact with objects in the pool. Polaris is not responsible for, and the Limited Warranty does not cover, pattern removal, abrasion or markings on vinyl liners.

Unique product shape is a registered trademark.

## Introduction

Congratulations on the purchase of your new automatic pool cleaner, and thank you for choosing Polaris. The Polaris Vac-Sweep 180 is designed to give you years of dependable and efficient service.

Like most mechanical devices, it will require periodic adjustments, routine maintenance, and the replacement of certain hardworking parts. Please have your cleaner checked occasionally by your local Polaris dealer or authorized service center.

Always insist on genuine Polaris replacement parts. Non-Polaris parts are not made to our specifications. They may have an adverse effect on the operation of your Polaris or may even damage it.

For best results, the Polaris 180 should be installed by a pool professional. For those with experience and confidence in handling plumbing and mechanical equipment, installation is outlined in this manual.

### Polaris 180 Complete Cleaner

- |                        |  |
|------------------------|--|
| 1. All Purpose Bag     | 7. Hose Floats   |
| 2. Head Float          | 8. Back-up Valve   |
| 3. Sweep Hose          | 9. Quick Disconnect with<br>Universal Wall Fitting (UWF) |
| 4. Sweep Hose Scrubber | 10. Restrictor Discs (one red and one blue)              |
| 5. Cleaner Body        |  |
| 6. Feed Hose           |  |

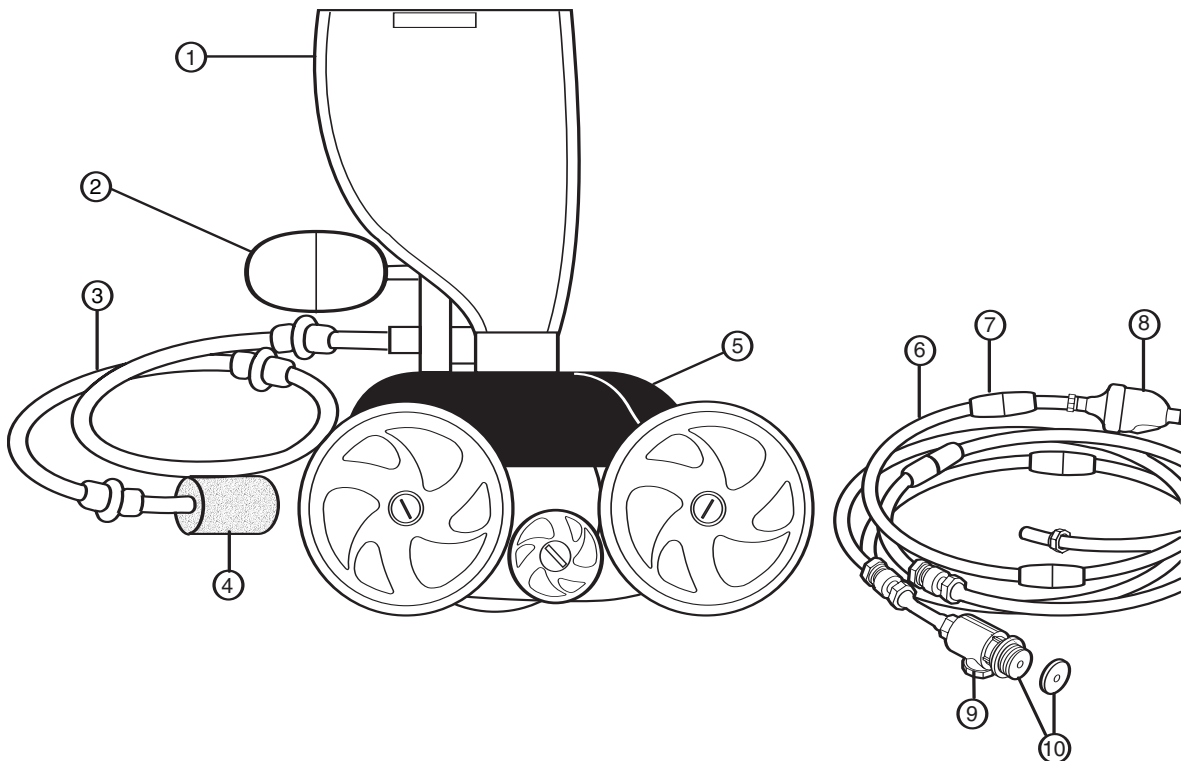

## Quick Installation Instructions

Four quick steps to install and get maximum performance from the Polaris 180:

- Install the Universal Wall Fitting (UWF) with Quick Disconnect
- Adjust feed hose to fit pool length
- Assemble the cleaner
- Check for proper wheel RPM (revolutions per minute)

### 1

#### Install the Universal Wall Fitting

Installs in minutes on pools with a dedicated cleaner return line and a threaded 1-1/2" female pipe fitting.

1. Turn on the filtration pump and flush out the plumbing line. Turn pump off.
2. Remove the UWF from the Quick Disconnect and screw the UWF with the blue restrictor disc into the return opening.
3. Turn the Quick Disconnect clockwise into the UWF and pull away to secure.

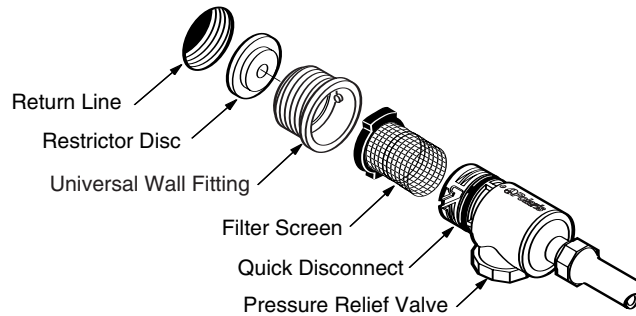

### 2

#### Adjust Feed Hose To Fit Pool Length

Measure the deepest part of the pool. Cut leader hose, from end that attaches to feed hose, so length is equal to the greatest depth of the pool.

Attach leader hose to feed hose and connect hose to the pool wall at the return line. Extend hose to farthest point of pool. The hose end must be within 6" – longer or shorter – of the farthest point. See dotted circle.

**Hose too long?** Separate hose at center swivel. Cut equal amounts of the overage from each 10-foot feed hose section.

**Hose too short?** Buy an additional feed hose section (part #9-100-3104), one swivel (part #D20) and two hose nuts (part #D15) from an authorized Polaris dealer.

After adjusting hose, position hose floats as shown..

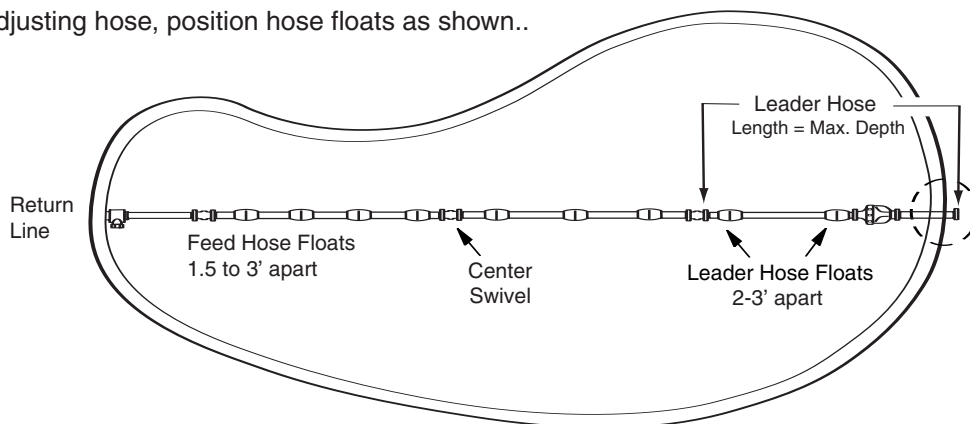

## 3

**Assemble the Cleaner**

1. Use the nut to attach the feed hose to the feed hose mast (feed pipe).
2. Pull out the bag and attach the Velcro strip loosely around the feed hose.
3. Position the head float 1/2 to 1 inch back from feed pipe.
4. Turn on the pool filtration pump and allow it to prime before turning on the booster pump.

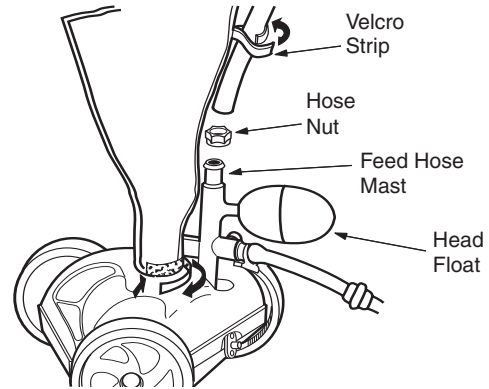

## 4

**Check for Proper RPM**

Before operating the Polaris, check for proper wheel revolutions per minute (RPM). For maximum efficiency, the Polaris should operate between 28 and 32 RPM.

1. Mark the single-wheel side tire.
2. Turn pump on, hold cleaner below water level and count wheel revolutions for 1 minute.
3. Optimum speed should be between 28 and 32 RPM.

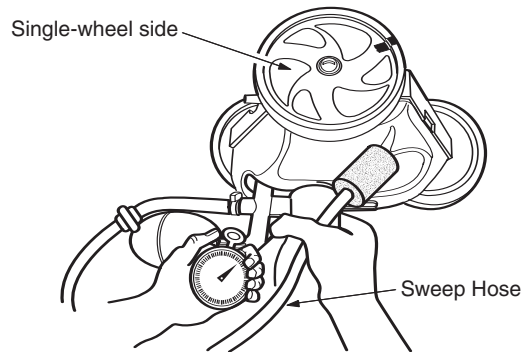

If count is **less than 28 RPM**:

- Check the filter screen in the Quick Disconnect for debris that restricts water flow.
- Clean the skimmer, filter and pump basket, clearing debris that restricts water flow.
- Check the hoses, connections and swivels for leaks that cause loss of water pressure.
- Remove the blue restrictor disc from the UWF.
- If an adjustable gate valve is installed on the booster pump or cleaner line, open it completely so water can flow freely to the Polaris.

If count is **more than 32 RPM**:

- Unscrew the pressure relief valve until the proper RPM is reached.
- If an adjustable gate valve is installed, adjust it to reduce the water flow to the cleaner.
- Replace the blue restrictor disc in the UWF with the red restrictor.

## Fine Tuning The Polaris Cleaner

When operating correctly, the Polaris 180 vacuums, sweeps and scrubs all surfaces randomly throughout the pool. The climbing ability of the Polaris depends on the pool's shape and water pressure or flow. The Polaris climbs best in pools without sharp angles or curves in the transition from the pool floor to the pool wall.

Approximately every 3 minutes the Polaris 180 goes into back-up mode. This action pulls the Polaris away from pool obstacles and increases its random pattern.

### Thrust Jet Adjustment

The thrust jet powers the direction of the Polaris. Factory position is straight back, but depending on the pool, other settings are helpful.

### Sweep Hose Adjustment

The sweep hose should move in a gentle sweeping motion. To increase or decrease its motion, turn off the booster pump and turn the sweep hose adjustment screw.

See Troubleshooting for other action adjustments.

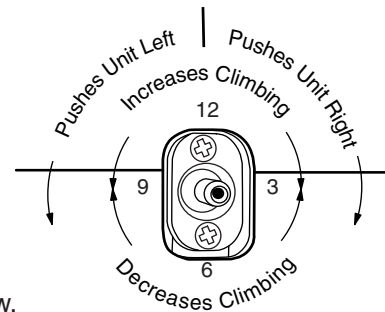

## Routine Maintenance

### Cleaning the Filter Bag

Remove the bag from the cleaner. Open the bag closure and dump out the debris.

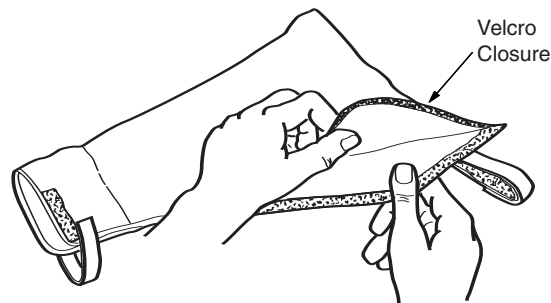

- Whenever possible, empty the filter bag when it is half full, especially if the dirt load is sand.
- It is easier to empty the filter bag when it is dry. Alternate between two filter bags. When one becomes full, remove it and put on the clean bag.

### Backwashing the Pool Filter

Always disconnect the Polaris from the pool wall before cleaning or backwashing the pool filter. After cleaning or backwashing, let the filtration system run for at least five minutes to flush out the return lines before re-connecting the Polaris.

### Storage and Winterizing

Never store the Polaris in direct sunlight. When storing for the winter, drain out all the water (freeze damage is not covered under the warranty). Remove the UWF from the pool wall by attaching the Quick Disconnect and using pulling pressure to unscrew. In some cases, it may be necessary to use the UWF Removal Tool (part #10-102-00) available from an authorized Polaris dealer.

# Polaris 180

## Exploded Parts Diagram

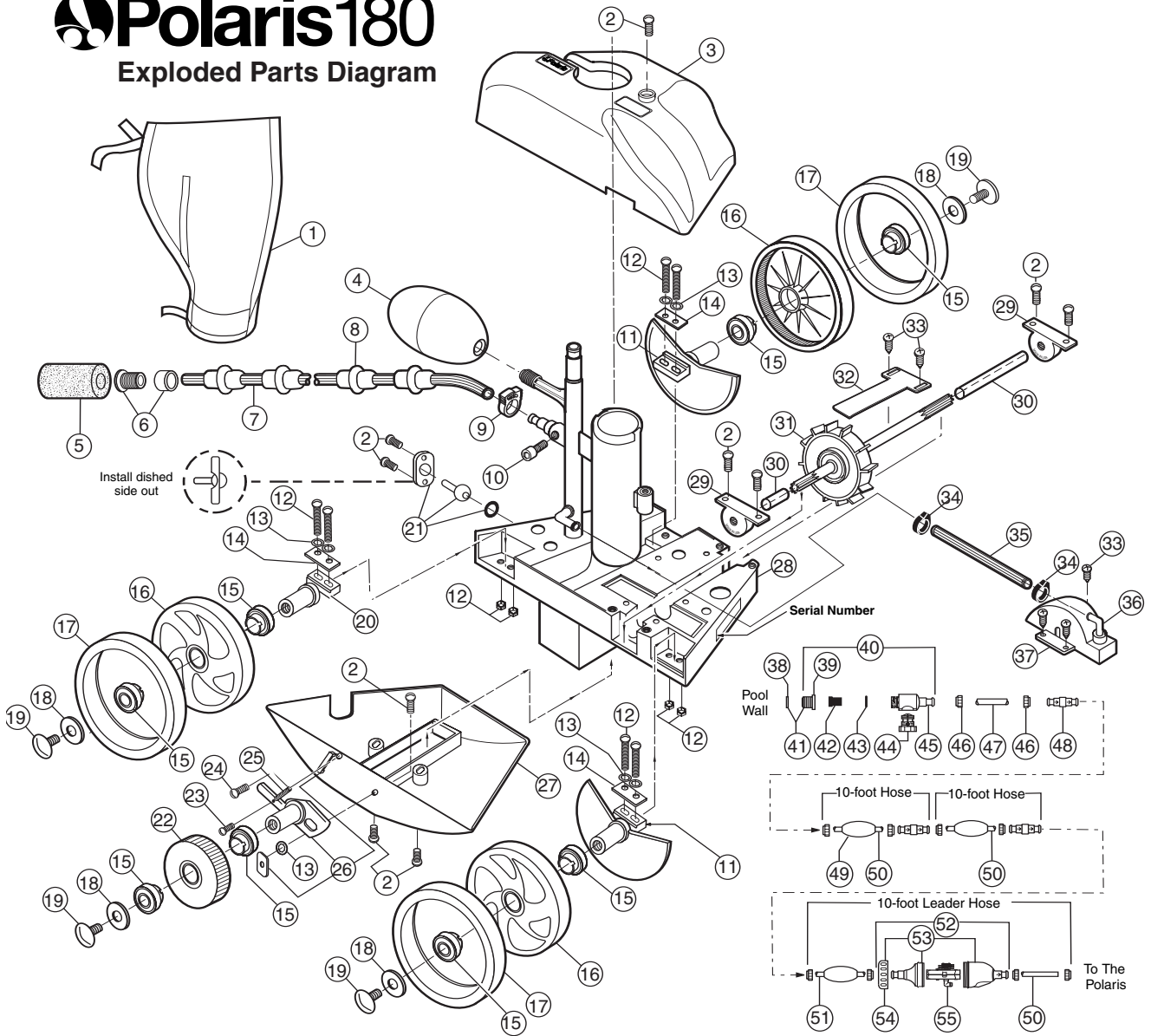

| No. | Part #     | Description                          | Qty | No. | Part #     | Description                      | Qty | No. | Part #     | Description                    | Qty |
|-----|------------|--------------------------------------|-----|-----|------------|----------------------------------|-----|-----|------------|--------------------------------|-----|
| 1   | A16        | All-Purpose Bag*                     | 1   | 18  | C64        | Wheel Washer, Plastic            | 4   | 37  | C110       | Turbine Cover with Elbow       | 1   |
| 2   | C40        | Screw, 10-32 x 3/8" SS Pan Head      | 10  | 19  | C55        | Wheel Screw, Plastic             | 4   | 38  | 10-112-00  | Restrictor Disks, Red and Blue | 1   |
| 3   | A5         | Top                                  | 1   | 20  | C65        | Axle, Large (Rear Wheel Only)    | 1   | 39  | 6-500-00   | Universal Wall Fitting (UWF)   | 1   |
| 4   | A20        | Float, Head                          | 1   | 21  | C131       | Thrust Jet Kit                   | 1   | 40  | 9-100-9001 | UWF Connector Assembly         | 1   |
| 5   | 9-100-3105 | Sweep Hose Scrubber*                 | 1   | 22  | C16        | Idle Wheel, Small                | 1   | 41  | 10-108-00  | UWF Restrictor Kit             | 1   |
| 6   | B25        | Orifice Tip w/Orifice Tip Guard      | 1   | 23  | C30        | Screw, 4-40 x 3/16" SS Pan Head  | 1   | 42  | 6-504-00   | Filter Screen, UWF/QD          | 1   |
| 7   | B5         | Sweep Hose Complete*                 | 1   | 24  | C32        | Screw, 6-32 x 1/2" SS Pan Head   | 1   | 43  | 6-505-00   | O-ring, UWF/QD                 | 1   |
| 8   | B10        | Wear Rings*                          | 8   | 25  | C25        | Spring for C-36                  | 1   | 44  | 9-100-9002 | Pressure Relief Valve, Black   | 1   |
| 9   | B15        | Sweep Hose Attach Clamp              | 1   | 26  | C36        | Swing Axle Kit                   | 1   | 45  | D29        | Quick Disconnect (QD), UWF     | 1   |
| 10  | B20        | Adjustment Screw, Sweep Hose         | 1   | 27  | A10        | Base with Bracket                | 1   | 46  | D15        | Nut, Feed Hose                 | 10  |
| 11  | C66        | Axle, Large (with Sand/Gravel Guard) | 2   | 28  | C145       | Frame                            | 1   | 47  | **         | Adapter Hose, 8-1/2"           | 1   |
| 12  | C75        | Screw/Nut, 10-32 x 7/8" SS Pan Head  | 6   | 29  | C80        | Ball Bearings, Turbine           | 2   | 48  | D20        | Swivel, Ball Bearing           | 3   |
| 13  | C45        | Lock Washer for C36                  | 7   | 30  | C83        | Turbine Shaft Tubes              | 1   | 49  | D10        | Float, Feed Hose               | 9   |
| 14  | C70        | Axle Plate for C65/C66               | 3   | 31  | C86        | Drive Shaft Assembly             | 1   | 50  | D45        | Feed Hose, 10 Ft               | 2   |
| 15  | C60        | Ball Bearings, Wheels                | 8   | 32  | A40        | Turbine Shaft Shield             | 1   | 51  | D50        | Feed Hose, Leader, 10 Ft       | 1   |
| 16  | C6         | Wheel, Large (No Bearings Incl.)     | 3   | 33  | A30        | Screw, #10 x 1/2" SS Pan Head    | 5   | 52  | G52        | Back-up Valve Kit              | 1   |
| 17  | C10        | Tire, MaxTrax**                      | 3   | 34  | 9-100-7170 | Hose Clamp for WMS               | 2   | 53  | G54        | Case Kit for G52               | 1   |
|     |            |                                      |     | 35  | C120       | Hose for C110, 7-1/2"            | 1   | 54  | G57        | Collar, Back-up Valve          | 1   |
|     |            |                                      |     | 36  | C115       | Elbow for C110 or Feed Mast Tube | 2   | 55  | G53        | Mechanism for G52              | 1   |

\*Wear items not covered by warranty.



## Troubleshooting

If the Polaris cleaner displays the following actions, adjustments may be necessary to restore performance. Refer to exploded parts diagram for part references.

**Action: Hangs up on steps or other obstacles for longer than 3 minutes.**

- Solution:
1. Check the wheel RPM.
  2. Verify the back-up valve is cycling.
  3. Adjust the thrust jet.
  4. Remove unnecessary pool hardware or install a Ladder Guard Kit (order part #G21 from a Polaris dealer).

**Action: Polaris is sluggish, running with less power than normal.**

- Solution:
1. Check the filter screen in the Quick Disconnect and clean, if necessary.
  2. Clean the skimmer basket, pump basket, and pool filter.
  3. Check all of the hoses, connections, and swivels for leaks that could cause loss of water pressure.
  4. Check the wheel RPM.

**Action: Polaris flies around the pool and/or does not make contact with the bottom.**

- Solution:
1. Check the wheel RPM. If more than 32 RPM, unscrew the pressure relief valve to decrease water flow to cleaner.
  2. Confirm that the blue restrictor disc is installed in the UWF to decrease water flow. Or, install the red restrictor disc to decrease water flow even more.

3. Verify the back-up valve is cycling. Hold the valve out of the water and watch the jet. It should come on and go off.

**Action: Polaris does not back up.**

- Solution:
1. Verify the back-up valve is cycling.
  2. Check the wheel RPM.
  3. If the bag is full, empty it.
  4. If head float has water in it, replace it.
  5. Make sure feed hose is floating.

**Action: Polaris only turns in one direction.**

- Solution:
1. Adjust the thrust jet.
  2. Make sure feed hose is floating.

**Action: Feed hose becomes tangled.**

- Solution:
1. Remeasure the hose to verify that it is adjusted to the proper length for the pool shape.
  2. With the Polaris operating, check that the swivels in the hose and the hose connections turn freely.
  3. Make sure feed hose is floating.
  4. With the Polaris turned off, spin each of the wheels. All wheels should turn together.

**Action: Sweep hose is sucked into the vacuum tube.**

- Solution:
1. Make sure the opening at the end of the sweep hose is not blocked by the sweep hose scrubber.
  2. Adjust the sweep hose to a gentle sweeping motion.



**Action:** Sweep hose sprays too much water out of the pool.

- Solution:**
1. Adjust the speed of the sweep hose by tightening the adjustment screw.
  2. Replace the sweep hose scrubber if it is worn or missing.
  3. Add a sweep hose weight (order part #B2) to keep the sweep hose from spraying.

**Action:** The cleaner does not clean the entire pool.

- Solution:**
1. Check the hose length reaches within 6" of the farthest point of the pool. If not, order a new hose section from your Polaris dealer.
  2. Check thrust jet for straight back position that optimizes random turning.
  3. While the cleaner is operating, hold it upside down and look into the vacuum tube. There should be one distinct jet of water. If there are not, contact Customer Service or a Polaris authorized Service Center for assistance.

**Action:** The cleaner is running in circles on its side.

- Solution:**
1. Check filter bag, if full it can weigh the cleaner down on one side.
  2. Remove the head float and shake it. If there is water in the float, order a new one.
  3. Check the hose floats to make sure they are spaced evenly.

## Troubleshooting Worksheet

If these solutions do not result in improved performance, contact the Polaris dealer who sold you the cleaner or call Customer Service.

In order to provide faster and more convenient service, please have the following information available at the time of your call or when taking the Polaris in for service.

1. **Serial #:** \_\_\_\_\_

2. **Wheel RPM:** \_\_\_\_\_

3. **Is the back-up valve cycling?**

Yes     No

4. **Is the feed hose the proper length?**

Yes     No

5. **Are the swivels rotating freely?**

Yes     No

6. **How often do you clean the filter screen inside the Quick Disconnect?**

Never                       Once a Week

Twice a Week     Once a Month

7. **Are the vacuum jets obstructed?**

(While the cleaner is operating, hold it upside down and look into the vacuum tube. There should be one distinct jet of water.)

Yes     No

8. **Is the drive train functioning?**

(As you spin each wheel independently, all the wheels should spin.)

Yes     No